



Swivel Joint - Type DG-02S

DN 20 - DN 150



Swivel Joint

Structure

- stator (outer part) and rotor (inner part) joined by a two-row ball bearing
- for-life lubrication provided in the factory
- welded connection parts: welding ends, pipe bends or flanges

Materials

basic unit	welding end	flange
1.7225	1.0305	1.0460
1.4571	1.4571	1.4571

Standard sealings

- PTFE compound sealings

Special sealings

- additional inner sealing for heavily polluted media
- hermetic radial sealing for underwater applications (from DN 65)
- medium sealings for oxygen, steam and food products

Pressure rating

- PN 16, PN 40 (1.7225) with flanges
- PN 250, PN 350 (1.7225) with welding ends
- PN 16, PN 40 (1.4571) with flanges
- PN 100 (1.4571) with welding ends
- higher pressures possible to max. PN 420

Surface protection

- Gas nitration
- Corrosion-protection primer

Design

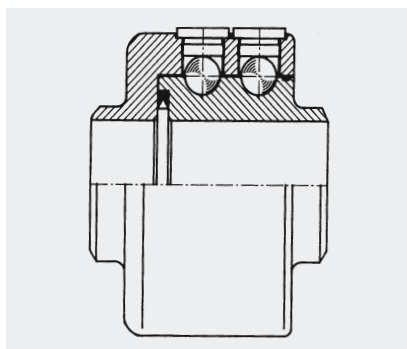

Type DG-02S basic unit with two-row ball bearing

Dimensions

Standard: DN 20 to DN 150
 Flanges: PN 16/PN 40 to EN 1092
 Others: possible to ANSI (ASA), BS etc.
 Welding end: to ISO recommendations

Notes

General technical instructions must be observed. Subject to technical alterations and fluctuations caused by the production process. Number of revolutions for swivel and rotation movements ≤ 10 rpm. Swivel movements in several planes see catalogue page 5/5. Sets of sealings and balls available individually as spare parts.

Anwendung

- robust design for liquid or gaseous media at high temperatures and particularly high pressures
- ideal for loads with high bending moments
- for slow swivel and rotation movements through 360°
- for rough operating conditions
 - in hydraulic flow pipes
 - at roll stands
 - in sewage plant
 - in steel mills
 - at hose drums
- for installation in flexible pipeline systems, for conveying media from a fixed point to any required flexible point
 - filling systems
 - loading and swivel arms
 - pipe joint shears
- use at test facilities
- special designs suitable for food products



STENFLEX® Swivel Joints type DG-02S installed at loading arms



Form 11 F / flange connection*

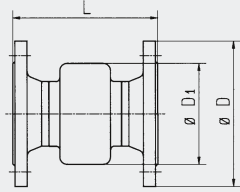

DN	ø D1 mm	1.7225				1.4571			
		PN 16		PN 40		PN 16		PN 40	
		ø D mm	L mm	ø D mm	L mm	ø D mm	L mm	ø D mm	L mm
20	72	105	174	105	174	105	174	105	174
25	78	115	174	115	174	115	174	115	174
32	88	140	178	140	178	140	178	140	178
40	104	150	184	150	184	150	184	150	184
50	118	165	194	165	200	165	194	165	200
65	133	185	204	185	218	185	204	185	218
80	139	200	214	200	230	200	214	200	230
100	175	220	218	235	244	220	218	235	244
125	218	250	254	270	280	250	254	270	280

Form 11 S / welding ends

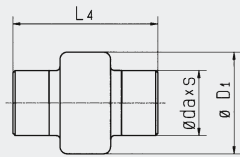

DN	ø D1 mm	ø d _a mm	1.7225				1.4571			
			PN 250		PN 350		PN 100			
			s mm	L ₄ mm	s mm	L ₄ mm	s mm	L ₄ mm	s mm	L ₄ mm
20	72	26.9	3.9	194	3.9	194	3.9	194	3.9	194
25	78	33.7	4.6	194	4.6	194	4.6	194	4.6	194
32	88	42.4	4.9	194	4.9	194	4.9	194	4.9	194
40	104	48.3	5.1	194	5.1	194	5.1	194	5.1	194
50	118	60.3	5.5	204	5.5	204	5.5	204	5.5	204
65	133	73.0	7.0	214				7.0	214	
80	139	88.9	7.6	214				7.6	214	
100	175	114.3	8.6	214				8.6	214	
125	218	141.3	9.5	244				9.5	244	

Form 12 F / flange connection*

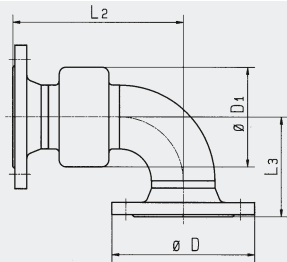

DN	ø D1 mm	1.7225						1.4571					
		PN 16			PN 40			PN 16			PN 40		
		ø D mm	L ₂ mm	L ₃ mm	ø D mm	L ₂ mm	L ₃ mm	ø D mm	L ₂ mm	L ₃ mm	ø D mm	L ₂ mm	L ₃ mm
20	72	105	159	67	105	159	67	105	172	80	105	163	71
25	78	115	159	67	115	159	67	115	172	80	115	172	80
32	88	140	168	76	140	168	76	140	184	92	140	184	92
40	104	150	177	85	150	177	85	150	196	104	150	196	104
50	118	165	200	98	165	203	101	165	225	123	165	228	126
65	133	185	222	110	185	229	117	185	254	142	185	261	149
80	139	200	240	128	200	248	136	200	278	166	200	286	174
100	175	220	268	156	235	281	169	220	318	206	235	331	219
125	218	250	326	184	270	339	197	250	389	247	270	402	260

Form 12 S / welding ends

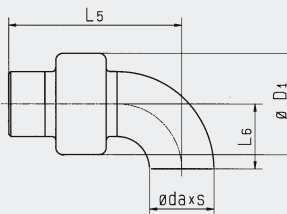

DN	ø D1 mm	ø d _a mm	1.7225						1.4571					
			PN 250			PN 350			PN 100					
			s mm	L ₅ mm	L ₆ mm	s mm	L ₅ mm	L ₆ mm	s mm	L ₅ mm	L ₆ mm	s mm	L ₅ mm	L ₆ mm
20	72	26.9	3.9	169	25	3.9	169	25	3.9	173	29			
25	78	33.7	4.6	169	25	4.6	169	25	4.6	182	38			
32	88	42.4	4.9	176	32	4.9	176	32	4.9	192	48			
40	104	48.3	5.1	182	38	5.1	182	38	5.1	201	57			
50	118	60.3	5.5	205	51	5.5	205	51	5.5	230	76			
65	133	73.0	7.0	227	63				7.0	259	95			
80	139	88.9	7.6	240	76				7.6	278	114			
100	175	114.3	8.6	266	102				8.6	316	152			
125	218	141.3	9.5	321	127				9.5	384	190			

Form 13 F / flange connection*

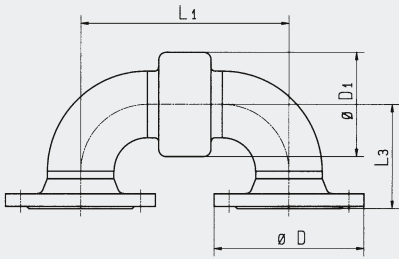

DN	ø D1 mm	1.7225						1.4571					
		PN 16			PN 40			PN 16			PN 40		
		ø D mm	L ₁ mm	L ₃ mm	ø D mm	L ₁ mm	L ₃ mm	ø D mm	L ₁ mm	L ₃ mm	ø D mm	L ₁ mm	L ₃ mm
20	72	105	144	67	105	144	67	105	170	80	105	152	71
25	78	115	144	67	115	144	67	115	170	80	115	170	80
32	88	140	158	76	140	158	76	140	190	92	140	190	92
40	104	150	170	85	150	170	85	150	208	104	150	208	104
50	118	165	206	98	165	206	101	165	256	123	165	256	126
65	133	185	240	110	185	240	117	185	304	142	185	304	149
80	139	200	266	128	200	266	136	200	342	166	200	342	174
100	175	220	318	156	235	318	169	220	418	206	235	418	219
125	218	250	398	184	270	398	197	250	524	247	270	524	260

Form 13 S / welding ends

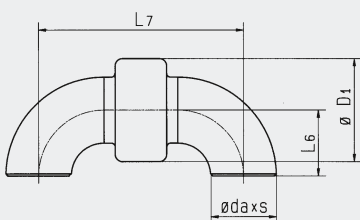

DN	ø D1 mm	ø d _a mm	1.7225						1.4571					
			PN 250			PN 350			PN 100					
			s mm	L ₆ mm	L ₇ mm	s mm	L ₆ mm	L ₇ mm	s mm	L ₆ mm	L ₇ mm	s mm	L ₆ mm	L ₇ mm
20	72	26.9	3.9	25	144	3.9	25	144	3.9	29	152			
25	78	33.7	4.6	25	144	4.6	25	144	4.6	38	170			
32	88	42.4	4.9	32	158	4.9	32	158	4.9	48	190			
40	104	48.3	5.1	38	170	5.1	38	170	5.1	57	208			
50	118	60.3	5.5	51	206	5.5	51	206	5.5	76	256			
65	133	73.0	7.0	63	240				7.0	95	304			
80	139	88.9	7.6	76	266				7.6	114	342			
100	175	114.3	8.6	102	318				8.6	152	418			
125	218	141.3	9.5	127	398				9.5	190	524			